

# OUTLINE DIMENSIONAL DRAWING

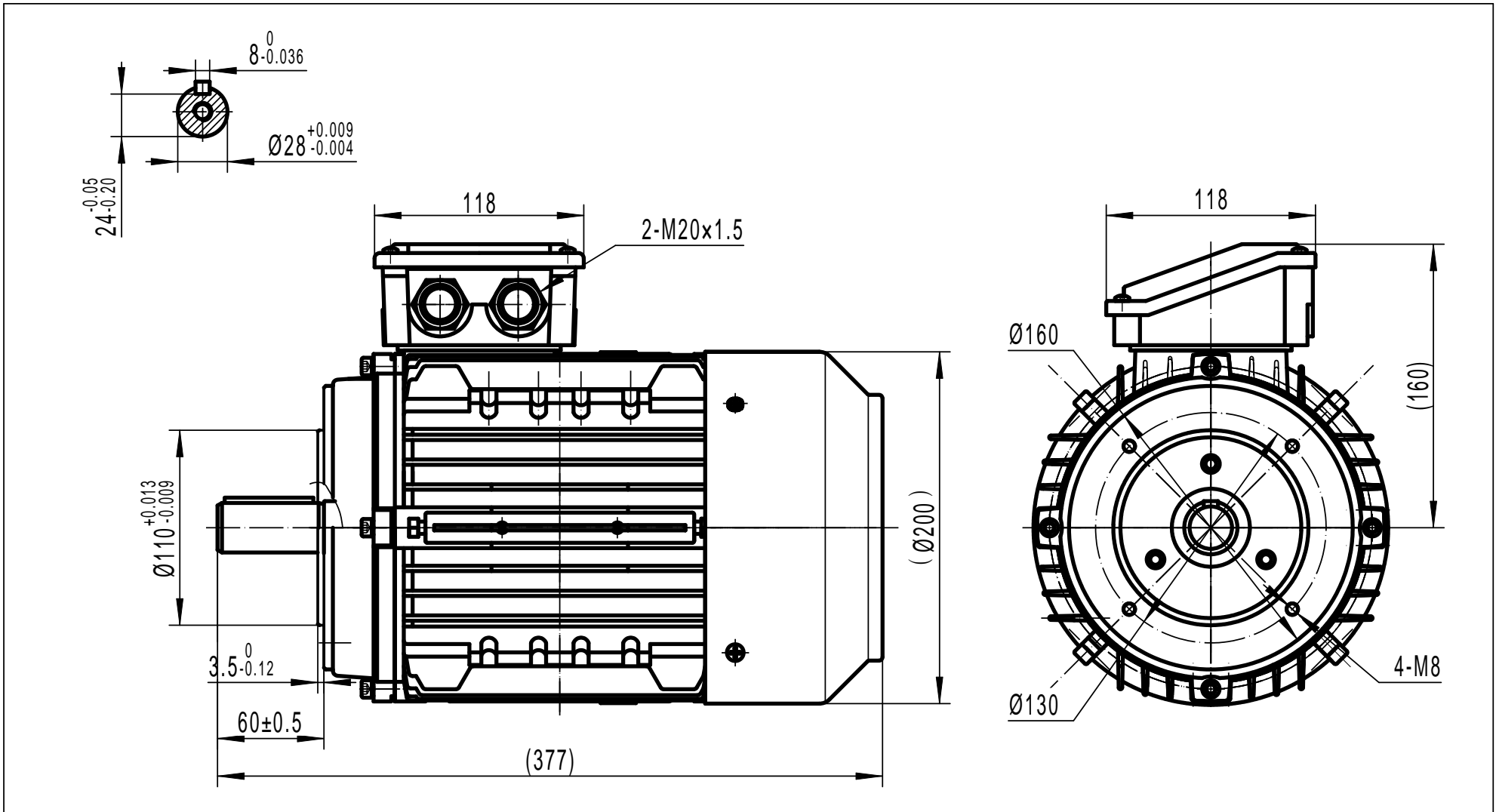

TECHTOP AUSTRALIA PTY LTD	
FRAME	TAI 100A B14
DATE	DRAWING NO.
2011/10/14	1ST085.060.001-021 A